



佛山市国星光电股份有限公司
FOSHAN NATIONSTAR OPTOELECTRONICS CO., LTD

产品规格书

SPECIFICATION

顾客名称 Customer		产品名称 Product	Chip LED
顾客型号 Customer Type		产品型号 Type	FC-D1608UGK-520D10
顾客部品号 Customer No.		版本号 Version NO	A 版



地址: 广东省佛山市禅城区华宝南路 18 号

Add: NO.18 South Huabao Rd, Foshan, Guangdong, China

电话 (Tel): 0757-82100219

传真 (Fax): 0757-82100220

邮编 (Zip): 528000

邮箱 (Email): chipLED@nationstar.com

<http://www.nationstar.com>

研发中心 Research & Development Center			客户 (加盖公章) Customer (Stamp)
制定 DRAW	审核 CHECK	批准 APPROVE	确认 CONFIRM
发放日期 (Release Date): 2016-05-25			

FC-D1608UGK-520D10

Chip Light Emitting Diode

技术数据表 Technical Data Sheet

本产品主要作为信号指示及照明的电子元件广泛应用于各类使用表面贴装结构的电子产品中,如家用电器的开关指示灯、手机键盘灯、汽车仪表盘指示灯等。

This product is generally used as indicator and luminance for surface mounted electronic equipment, such as household appliance, communication equipment, and dashboard.

特性:

➤ 管芯材料: InGaN
Material:

发光颜色: 绿色
Emitting Color: Green

Features:

➤ 封装材料: 环氧树脂

Encapsulation: Epoxy Resin

➤ 焊接方法: 无铅回流焊

Soldering methods: Pb-Free reflow soldering

➤ 光强高, 功耗低, 可靠性好, 寿命长

High Luminous Intensity, Low Power Dissipation, Good Reliability and Long Lifespan

➤ 符合欧盟公布的 ROHS 指令要求

Complied With ROHS Directive



* 产品规格如因工艺改进而有所改变, 恕不另行通知。
* The specifications of the product may be modified for improvement without notice.

外形尺寸

Outline Dimension

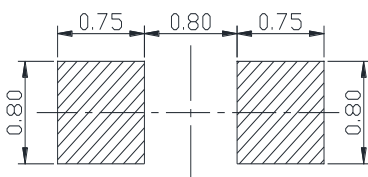
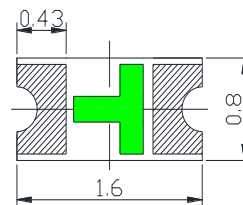
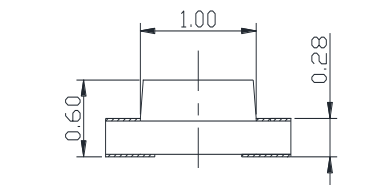
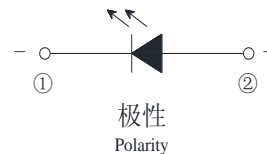
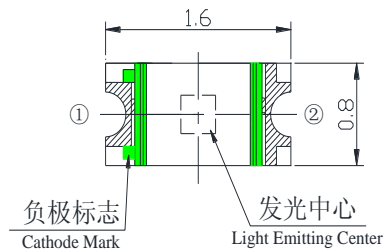

推荐焊盘尺寸

Recommended Soldering Pad

敷铜区域: Cuprum Area:
阻焊丝印区域: Solder Resist:
无特别规定时, 公差: X.X±0.1mm, X.XX±0.05mm单位为mm
* The Tolerances Unless Mentioned is: X.X±0.1mm, X.XX±0.05mm, Unit= mm*

光电参数 (1)

Electro-Optical Characteristics(1)

极限参数 (温度=25℃)



Absolute Maximum Ratings (Temperature=25 °C)

参数名称 Parameter	符号 Symbol	数值 Rating	单位 Unit
正向电流 Forward Current	I_F	20	mA
正向脉冲电流* Pulse Forward Current*	I_{FP}	50	mA
反向电压 Reverse Voltage	V_R	5	V
工作温度 Operating Temperature	T_{OPR}	-30 ~ +85	°C
贮存温度 Storage Temperature	T_{stg}	-40 ~ +100	°C
功耗 Power Dissipation	P_D	72	mW

* 注: 脉冲宽度 $\leq 0.1ms$, 占空比 $\leq 1/10$ * Note: Pulse Width $\leq 0.1ms$, Duty $\leq 1/10$

光电参数 (温度=25℃)



Electro-Optical Characteristics (Temperature=25 °C)

参数名称 Parameter	符号 Symbol	条件 Condition	最小值 Min.	典型值 Typ.	最大值 Max.	单位 Unit
反向电流 Reverse Current	I_R	$V_R=5V$	-	-	10	μA
视角 View Angle	$2\theta_{1/2}$	-	-	130	-	deg.
正向电压 Forward Voltage	V_F	$I_F=10mA$	2.6	3.0	3.6	V
峰值波长 Peak Wavelength	λ_P		-	520	-	nm
主波长 Dominant Wavelength	λ_d		515	522	530	nm
半波宽度 Spectrum Radiation Bandwidth	$\Delta\lambda$		-	30	-	nm
光强 Luminous Intensity	I_V		330	650	900	mcd

* 注 1: 光强偏差 $\pm 15\%$; 压降偏差 $\pm 0.1V$; (X,Y)坐标偏差 ± 0.01 ; 单色光波长偏差 $\pm 1nm$ 。

* Note1: Tolerance on each Luminous Intensity bin is $\pm 15\%$; Tolerance on each Forward Voltage bin is $\pm 0.1V$; Tolerance on each Hue(X,Y) bin is ± 0.01 ; Tolerance of Dominant Wavelength $\pm 1nm$.

* 注 2: 以上参数仅供参考, 请以实物标签为准。我司给出的参数均由国星测试系统测得。

* Note2: The parameters above are only for your reference. In case of any discrepancy, please adhere to the label of our actual products. All parameters are tested by the standard testing system of NationStar.

光电参数 (2)

Electro-Optical Characteristics(2)

◇ 正向电压 (温度=25℃, 测试电流=10 mA)

Forward Voltage (Ta=25 °C,IF=10mA)

典型电压档范围 Voltage Classification Range	
V _F	2.8-3.0 V
	3.0-3.2 V
	3.2-3.4 V

◇ 光强 (温度=25℃, 测试电流=10 mA)

Luminous Intensity (Ta=25 °C,IF=10mA)

典型光强档范围 Luminous Classification Range	
I _V	330-400 mcd
	400-500 mcd
	500-600 mcd
	600-750 mcd
	750-900 mcd

◇ 主波长 (温度=25℃, 测试电流=10 mA)

Dominant Wavelength (Ta=25 °C,IF=10mA)

典型波长档范围 Dominant Wavelength Range	
λ _d	515-518 nm
	518-521 nm
	521-524 nm
	524-527 nm

典型特性曲线

Typical Characteristics Curves

伏安特性
Volt-Ampere Characteristics

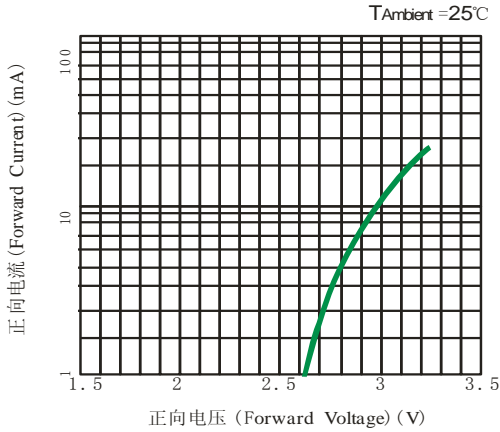

相对光强与正向电流特性
Relative Luminous Intensity VS Forward Current

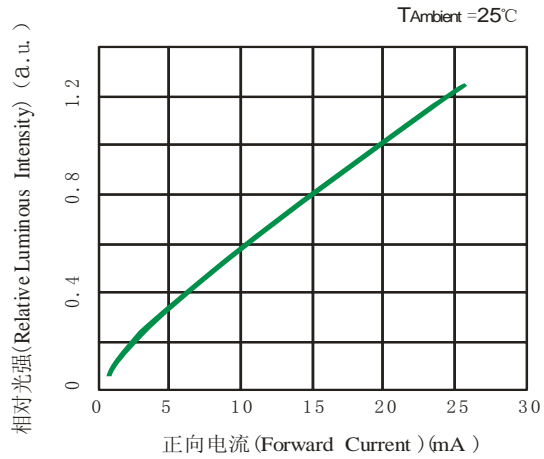

正向电流降额曲线
Forward Current Derating Curve

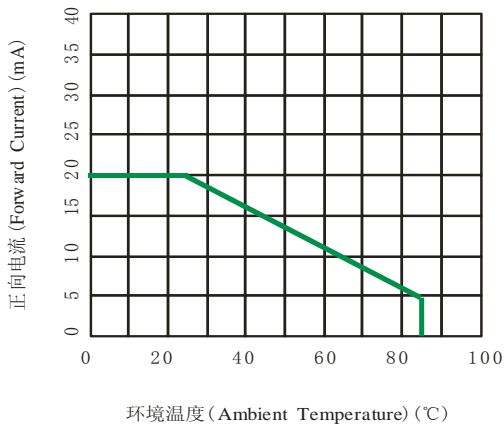

光强与环境温度曲线
Luminous Intensity VS Ambient Temperature

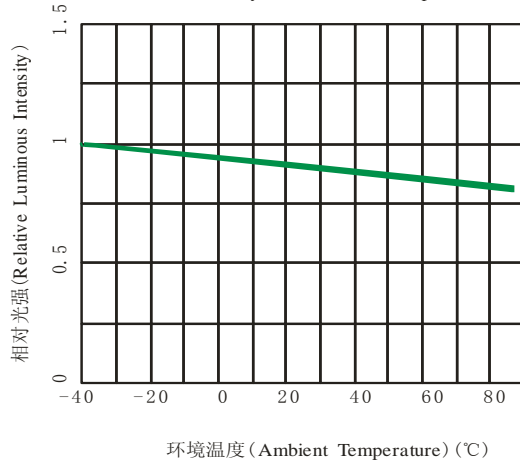

相对光强 (Relative Luminous Intensity) (a.u.)

光谱分布特性曲线
Relative Spectral Distribution

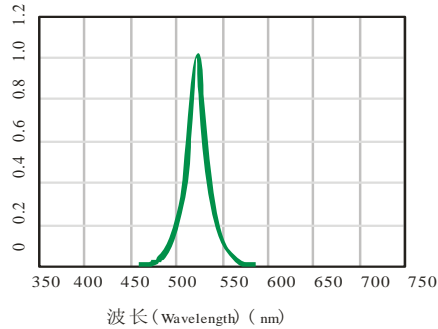

光强分布特性曲线
Typical Spatial Distribution

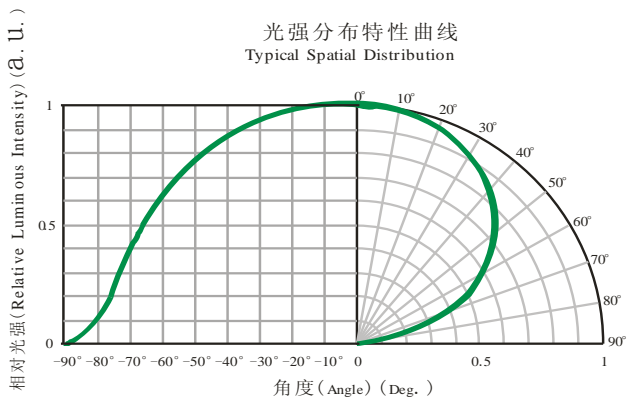



可靠性试验

Reliability Test Items And Conditions

实验项目 Test Items	参考标准 Reference	实验条件 Test Conditions	时间 Time	样品数 Quantity	判据 Criterion
冷热冲击 Thermal Shock	MIL-STD-202G	-40°C(15min)←→100°C(15min)	循环 200 次 200 cycles	22	0/22
湿热循环 Temperature And Humidity Cyclic	JEITA ED-4701 200 203	(-10~65)°C , (0~90)%RH 24hrs./1cycle	循环 10 次 10 cycles	22	0/22
高温储存 High Temperature Storage	JEITA ED-4701 200 201	Ta=100°C	1000h	22	0/22
低温储存 Low Temperature Storage	JEITA ED-4701 200 202	Ta=-40°C	1000h	22	0/22
常温寿命试验 Lifespan Test	JESD22-A108D	Ta=25°C IF = 10mA	1000h	22	0/22
耐焊接热 Resistance to Soldering Heat	GB/T 4937, II ,2.2&2.3	Tsol*=(260±5)°C 10secs.	2 次 2 times	22	0/22

失效判断标准 Criteria For Judging Damage

测试项目 Test Items	符号 Symbol	测试条件 Test Conditions	判定标准 Criteria For Judging Damage
正向电压 Forward Voltage	V _F	I _F = I _{FT}	初始值 ±10% Initial Data ±10%
反向电流 Reverse Current	I _R	V _R = 5V	I _R ≤ 10μA
光强 Luminous Intensity	I _V	I _F = I _{FT}	平均 I _V 衰减 ≤ 30% , 单个 I _V 衰减 ≤ 50% Average IV degradation ≤ 30%; Single LED IV degradation ≤ 50%
耐焊接热 Resistance to Soldering Heat			材料无内部裂痕、无材料间爆裂、剥离、无死灯。 Material without internal cracks, no material between stripped, no dead light .

* 注: Tsol-锡液温度; I_{FT}: 典型电流

* Note: Tsol-Temperature of tin liquid; I_{FT}: Typical current.

包装 (1)

Packaging (1)

◇ 载带 Carrier Tape

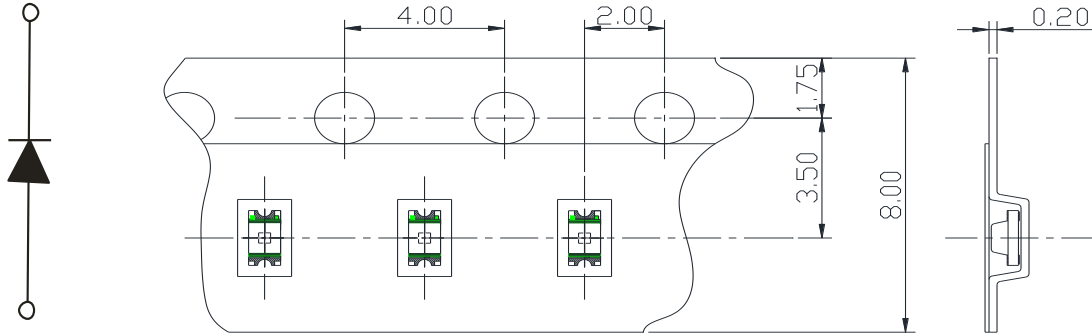

单位: mm, 未注公差: ± 0.1 mm
All dimensions in mm, tolerances unless mentioned is ± 0.1 mm.

◇ 编带细节 Details Of Carrier Tape

前进方向 Progressive Direction →

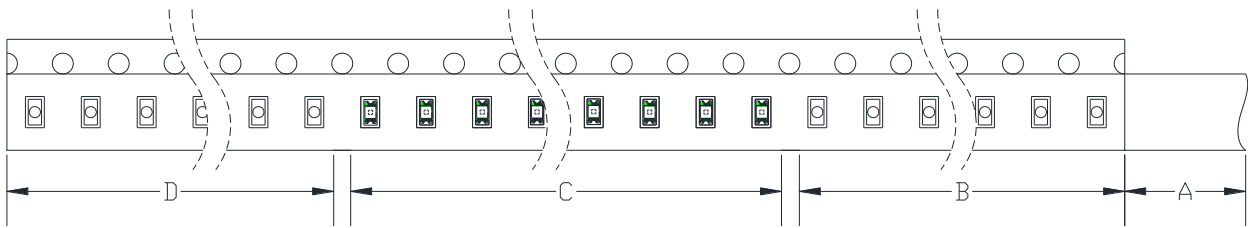

A: 盖带, 200 mm; B: 引导, 空带, 100mm; C: 编载产品 4000 只; D: 尾部, 空带, 100mm
A: Top Cover Tape, 200mm; B: Leader, Empty, 100mm; C: 4000 Lamps Loaded; D: Trailer, Empty, 100mm.

◇ 带盘 Reel Dimension

前进方向 Progressive Direction →

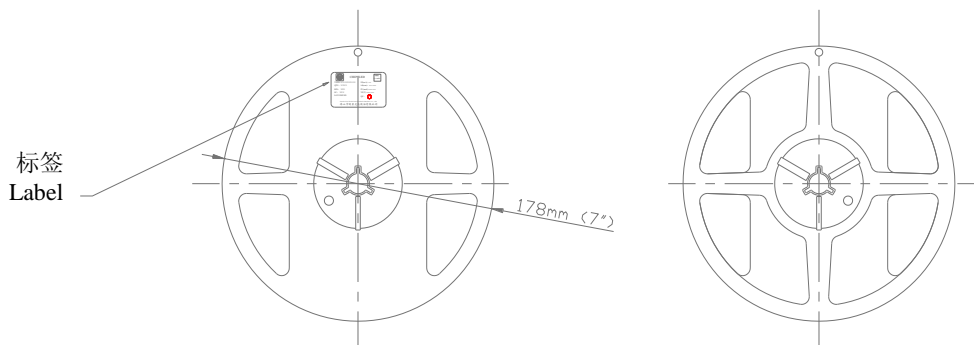

包装 (2)

Packaging (2)

防潮抗静电包装 Moisture Proof and Anti-Electrostatic Foil Bag

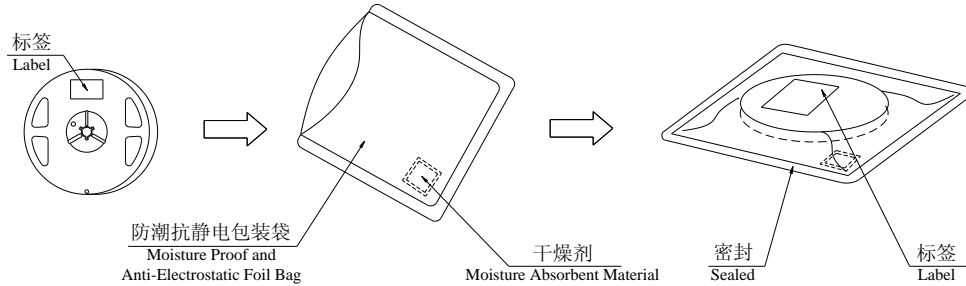

外包装箱 Cardboard Box

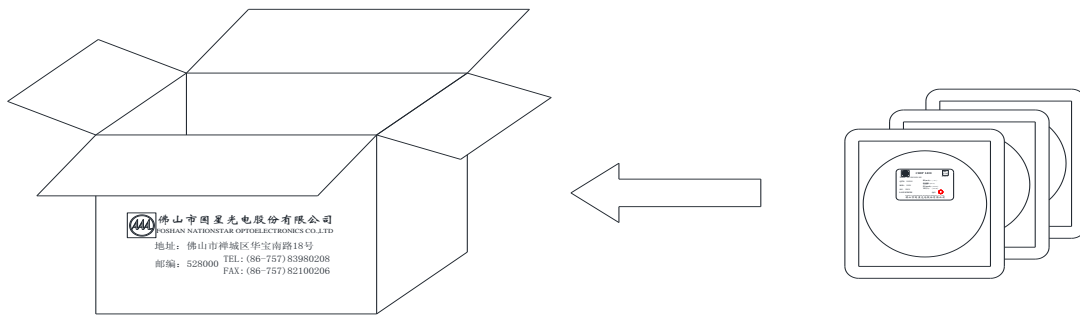

标签说明 Label Explanation

TYPE: 产品型号

QTY: 数量 Quantity

BIN: 分档 Rank

SC: 分档编号 Step Code

LOT: 批号 Lot Number

λd : 波长范围 Wavelength Range

IV: 光强范围 Luminous Intensity Range

VF: 正向电压范围 Forward Voltage Range

IF: 测试电流 Testing Current

